

One-way flow control valves GRLA, GRLZ

FESTO



Festo Core Range
Solves the majority of your automation tasks

Worldwide: Quickest delivery – wherever, whenever
Simply good: Expected high Festo quality
Fast: Easy and fast to select

With the Festo Core Range, we have selected the most important products and functions from our broad product catalogue, and added the quickest delivery.

The Core Range offers you the best value for your automation tasks.

Just look
for the
star!

Key features

Function

The piston speed of both advancing and retracting pneumatic cylinders can be regulated using one-way flow control valves.

This is done through suitable restriction of the flow rate of compressed air in exhaust air or supply air direction. The non-return function works in the opposite direction.

The flow control function creates an adjustable annular gap inside the valve. This gap can be increased or decreased by turning the knurled screw or slotted head screw.

The required restriction can be set with the help of this adjustment element.

General information

Standard nominal flow rate q_{nN}

The standard nominal flow rate q_{nN} is the volumetric flow rate based on standard conditions at an operating pressure of $p_1 = 6$ bar and an output pressure of $p_2 = 5$ bar, measured at room temperature $t = 20^\circ\text{C}$.

Standard flow rate q_n

The standard flow rate q_n is measured at an operating pressure of $p_1 = 6$ bar and an output pressure with respect to atmospheric pressure ($p_2 = 0$ bar).

Symbols

Exhaust air one-way flow control function

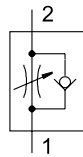

Supply air one-way flow control function

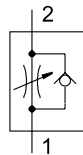

Connections

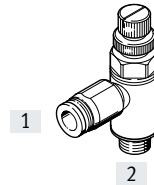

- [1] Pneumatic connection 1 (compressed air connection)
- [2] Pneumatic connection 2 (working port)

Key features

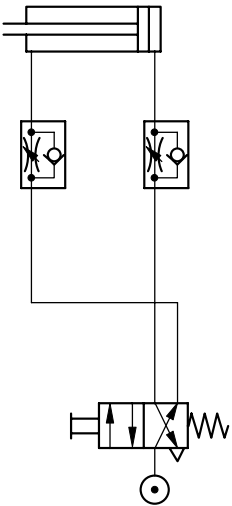
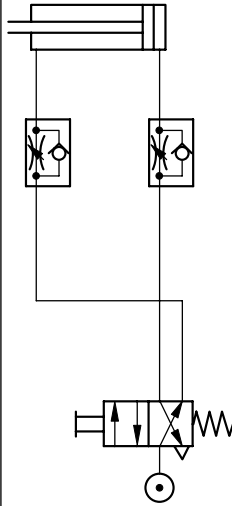
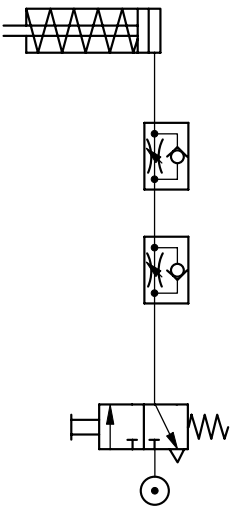
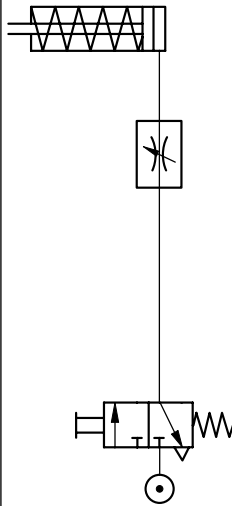
| Flow control functions and range of applications | | Flow control functions and range of applications | |
|--|--|---|--|
| Application | Description | Application | Description |
| Double-acting cylinder with one-way flow control valve | | | |
| Exhaust air one-way flow control function | | Supply air one-way flow control function | |
|  | <p>Speed is adjustable using exhaust air flow control. Free flowing supply air and throttled exhaust air ensure that the piston moves between the air pockets (improves motion, even with load changes).</p> |  | <p>Speed is adjustable for advance and return strokes. The flow rate is identical in both directions.</p> |
| Single-acting cylinder with one-way flow control valve | | Single-acting cylinder with flow control valve | |
| Exhaust air and supply air one-way flow control function | | Flow control function in both directions | |
|  | <p>Speed is adjustable for advance and return strokes. The flow rate can be adjusted differently for both directions.</p> |  | <p>Speed adjustment through flow control on both sides is often used with single-acting or small cylinders. The benefit of this application is its simplicity.</p> |







Application examples

Mini slide SLT with one-way flow control valve, standard

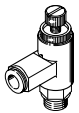
Flat cylinder DZF with one-way flow control valve, mini



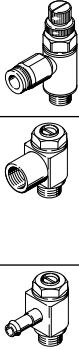



Product range overview – One-way flow control valves

| Design | Valve function | Design | Type | Outlet direction of connection | Pneumatic connection 1 | Pneumatic connection 2 | qnN ¹⁾ [l/min] | Adjusting element | → Page/ Internet |
|---|---|---------|--------------|--------------------------------------|--|------------------------|-------------------------------------|-------------------------------------|------------------|
| Standard | | | | | | | | | |
| Polymer | | | | | | | | | |
| Exhaust air one-way flow control function |  | VFOE-LE | Elbow outlet | QS-4, QS-6, QS-8, QS-10, QS-12 | M5, G1/8, G1/4, G3/8, G1/2, R1/8, R1/4, R3/8, R1/2 | | 90 ... 1200 | Rotary knob with latch | vfoe |
| |  | GRLA | Elbow outlet | QS-6, QS-8 | G1/8, G1/4, G3/8 | | 520 ... 650 | Knurled screw | 19 |
| Supply air one-way flow control function |  | VFOE-LS | Elbow outlet | QS-4, QS-6, QS-8 | M5, M7, G1/8, R1/8 | | 90 ... 180 | Rotary knob with latch | vfoe |
| Metal | | | | | | | | | |
| Exhaust air one-way flow control function |  | GRLA | Elbow outlet | QS-3, QS-4, QS-6, QS-8, QS-10, QS-12 | M5, G1/8, G1/4, G3/8, G1/2 | | 100 ... 1580 | Slotted head screw Knurled screw | 7 |
| | | | | M5, G1/8, G1/4, G3/8, G1/2, G3/4 | M5, G1/8, G1/4, G3/8, G1/2, G3/4 | 95 ... 4320 | Slotted head screw | | |
| | | | | M5, G1/8, G1/4 | M5, G1/8, G1/4 | 95 ... 610 | Knurled screw | | |
| | | | | PK-3, PK-4, PK-6 | M5, G1/8, G1/4 | 83 ... 540 | Slotted head screw | | |
| |  | GRLSA | Elbow outlet | QS-6, QS-8 | G1/8, G1/4 | | 0 ... 450 | Rotary knob with scale, hex socket | 16 |
| Supply air one-way flow control function |  | GRLZ | Elbow outlet | QS-3, QS-4, QS-6, QS-8 | M5, G1/8 | | 100 ... 215 | Slotted head screw | 7 |
| | | | | M5, G1/8, G1/4 | M5, G1/8, G1/4 | 95 ... 610 | Slotted head screw Knurled screw | | |
| | | | | PK-3, PK-4, PK-6 | M5, G1/8, G1/4 | 83 ... 540 | Slotted head screw | | |
| |  | VFOC-S | Elbow outlet | QS-4, QS-6 | Push-in sleeve ²⁾ QS-4, QS-6 | | 0 ... 270 | Slotted head screw | vfoc |
| Nickel-plated metal | | | | | | | | | |
| Exhaust air one-way flow control function |  | VFOH-LE | Elbow outlet | QS-4, QS-6, QS-8, QS-10 | G1/8, G1/4 | | 180 ... 530 | External hex | vfoh |

1) Standard nominal flow rate in flow control direction.

2) Only suitable for push-in connector QS.

Product range overview – One-way flow control valves

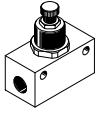
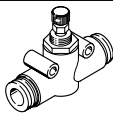
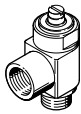
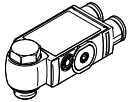
| Design | Valve function | Design | Type | Outlet direction of connection | Pneumatic connection 1 | Pneumatic connection 2 | qn ¹⁾ [l/min] | Adjusting element | → Page/ Internet |
|---|---|---|--------|--------------------------------|--------------------------------------|--------------------------------------|-----------------------------|--------------------|---------------------|
| Mini | Metal | | | | | | | | |
| | Exhaust air one-way flow control function |  | GRLA | Elbow outlet | QS-3, QS-4 | M3, M5 | 40 ... 41 | Slotted head screw | 21 |
| | |  | | | M3 | M3 | 0 ... 18 | Slotted head screw | |
| | Supply air one-way flow control function |  | GRLZ | Elbow outlet | QS-3, QS-4 | M3, M5 | 41 ... 48 | Slotted head screw | |
|  | | M3 | | | M3 | 0 ... 18 | Slotted head screw | | |
| In-line installation | Metal | | | | | | | | |
| | One-way flow control function |  | GR/GRA | Straight | M3, M5, G1/8, G1/4, G3/8, G1/2, G3/4 | M3, M5, G1/8, G1/4, G3/8, G1/2, G3/4 | 29.5 ... 3300 | Knurled screw | gr |
| In-line installation | Polymer | | | | | | | | |
| | One-way flow control function |  | GR | Straight | QS-3, QS-4, QS-6, QS-8 | QS-3, QS-4, QS-6, QS-8 | 85 ... 265 | Knurled screw | gr |
| Corrosion-resistant | Stainless steel | | | | | | | | |
| | Exhaust air one-way flow control function |  | CRGRLA | Elbow outlet | M5, G1/8, G1/4, G3/8, G1/2 | M5, G1/8, G1/4, G3/8, G1/2 | 95 ... 2100 | Slotted head screw | 26 |
| Function combination | Polymer | | | | | | | | |
| | Exhaust air one-way flow control function |  | VFOF | Elbow outlet | QS-6, QS-8 | G1/8, G1/4 | 240 ... 590 | Hex socket | vfof |

1) Standard nominal flow rate in flow control direction.

One-way flow control valves

Type codes

| 001 | Series |
|---------------|---|
| GRLA | One-way flow control valve |
| GRLSA | One-way flow control valve |
| CRGRLA | One-way flow control valve, corrosion resistant |
| GRLZ | One-way flow control valve |

| 002 | Pneumatic connection |
|------------|----------------------|
| M3 | Male thread M3 |
| M5 | Male thread M5 |
| 1/8 | Male thread G1/8 |
| 1/4 | Male thread G1/4 |
| 3/8 | Male thread G3/8 |
| 1/2 | Male thread G1/2 |
| 3/4 | Male thread G3/4 |

| 003 | Pneumatic connection 1 |
|--------------|------------------------------------|
| | Connection size as for port 1 or 2 |
| QS-3 | Push-in connector 3 mm |
| QS-4 | Push-in connector 4 mm |
| QS-6 | Push-in connector 6 mm |
| QS-8 | Push-in connector 8 mm |
| QS-10 | Push-in connector 10 mm |
| QS-12 | Push-in connector 12 mm |
| PK-3 | CK connection 3 mm |
| PK-4 | CK connection 4 mm |
| PK-6 | CK connection 6 mm |

| 004 | Adjusting component |
|-----------|---------------------|
| | Standard |
| RS | Knurled screw |

| 005 | Flow rate characteristic |
|-----------|--------------------------|
| | None |
| LF | Low flow |
| MF | Medium flow |

| 006 | Generation |
|----------|------------|
| | None |
| B | Series B |
| C | Series C |
| D | D series |



Datasheet – Push-in connector QS, metal

One-way flow control function

Exhaust air

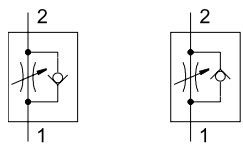
Supply air



-  - Flow rate
100 ... 1580 l/min
-  - Temperature range
-10 ... +60°C
-  - Operating pressure
0.2 ... 10 bar

Can be rotated 360° around the screw-in axis after installation.



| General technical data – GRLA | | | | | | |
|-------------------------------|---|------------------|------------------------|-------------------|-------------------|---------|
| Pneumatic connection 2 | | M5 | G1/8 | G1/4 | G3/8 | G1/2 |
| Pneumatic connection 1 | | QS-3, QS-4, QS-6 | QS-3, QS-4, QS-6, QS-8 | QS-6, QS-8, QS-10 | QS-6, QS-8, QS-10 | QS-12 |
| Valve function | Exhaust air one-way flow control function | | | | | |
| Adjusting element | Slotted head screw | | | | | |
| | Knurled screw | | | | | |
| Type of mounting | Screw-in, via male thread | | | | | |
| Mounting position | Any | | | | | |
| Nominal tightening torque | [Nm] | 0.8 ±10% | 3 ±10% | 5 ±10% | 10 ±10% | 15 ±10% |

| General technical data – GRLZ | | | |
|-------------------------------|--|------------------------|--------|
| Pneumatic connection 2 | M5 | G1/8 | |
| Pneumatic connection 1 | QS-3, QS-4, QS-6 | QS-3, QS-4, QS-6, QS-8 | |
| Valve function | Supply air one-way flow control function | | |
| Adjusting element | Slotted head screw | | |
| Type of mounting | Screw-in, via male thread | | |
| Mounting position | Any | | |
| Nominal tightening torque | [Nm] | 0.8 ±10% | 3 ±10% |

| Operating and environmental conditions | |
|---|--|
| Operating pressure for full temperature range | [bar] 0.2 ... 10 |
| Operating medium | Compressed air to ISO 8573-1:2010 [7:4:4] |
| Note on the operating/pilot medium | Lubricated operation possible (in which case lubricated operation will always be required) |
| Ambient temperature | [°C] -10 ... +60 |
| Temperature of medium | [°C] -10 ... +60 |
| Storage temperature | [°C] -10 ... +40 |
| Maritime classification | See certificate ¹⁾ |

1) Additional information: www.festo.com/catalogue/grla → Support/Downloads

Standard nominal flow rate q_{nN} at 6 → 5 bar as a function of spindle rotations n

GRLA/GRLZ-M5

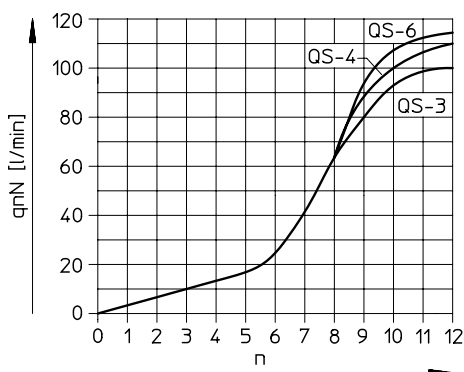

Standard flow rate q_n at 6 → 0 bar as a function of spindle rotations n

GRLA/GRLZ-M5

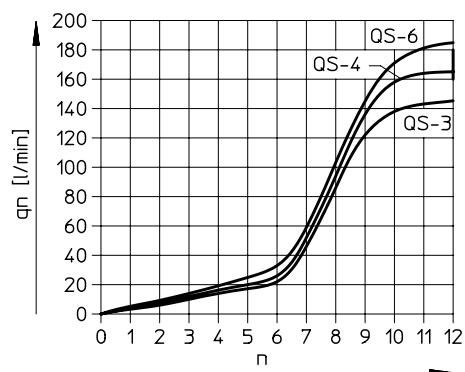

Datasheet – Push-in connector QS, metal

Standard nominal flow rate q_{nN} at 6 → 5 bar as a function of spindle rotations n

GRLA/GRLZ-1/8

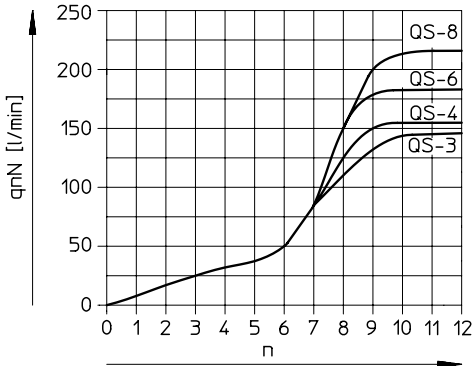

Standard flow rate q_n at 6 → 0 bar as a function of spindle rotations n

GRLA/GRLZ-1/8

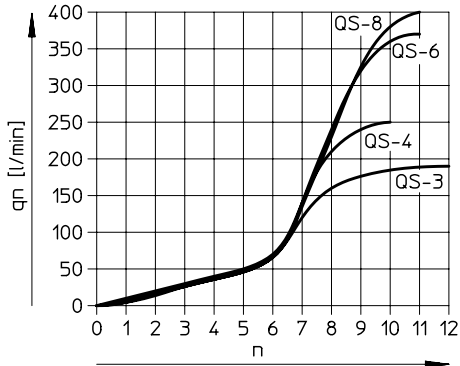

GRLA-1/8...-MF, GRLA-1/4

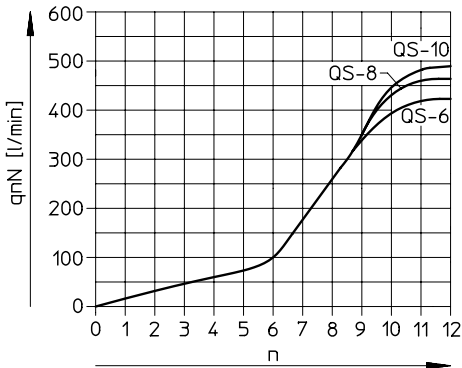

GRLA-1/8...-MF, GRLA-1/4

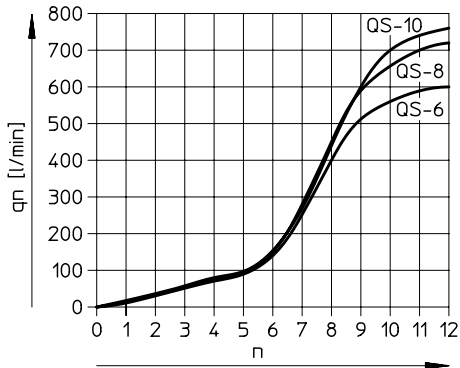

GRLA-3/8

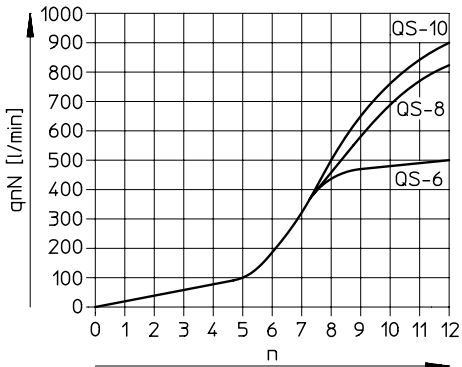

GRLA-3/8

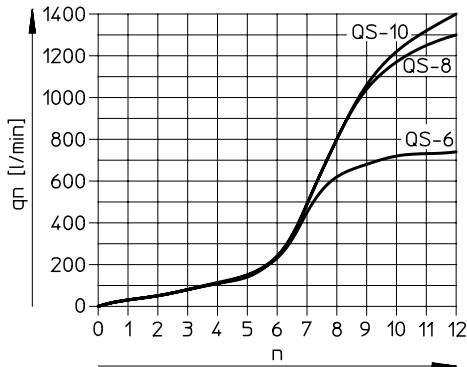

GRLA-1/2

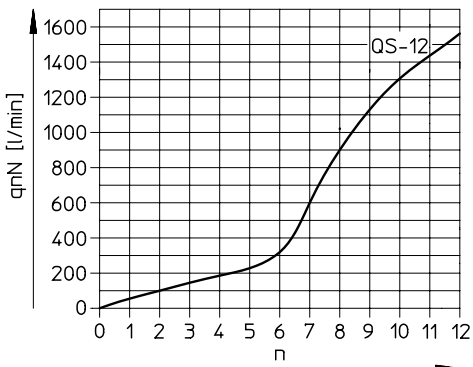

GRLA-1/2

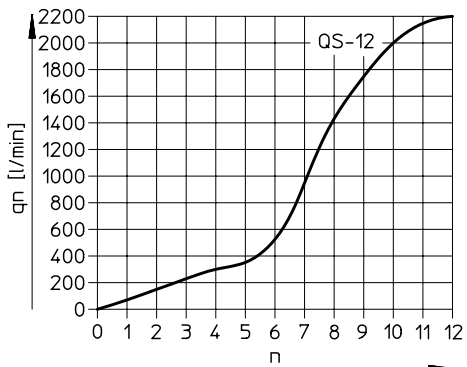

Datasheet – Push-in connector QS, metal

Materials

Sectional view

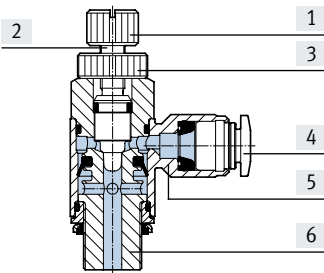

One-way flow control valve

| | | |
|-------------------|---------------------------------|---|
| [1] | Knurled head (GRLA-...-RS only) | Anodised wrought aluminium alloy |
| [2] | Adjusting screw | Brass |
| [3] | Hollow bolt (GRLA-...-RS only) | Anodised wrought aluminium alloy |
| [4] | Releasing ring | POM |
| [5] | Swivel joint | Chromated die-cast zinc |
| [6] | Screwed trunnion | Anodised wrought aluminium alloy GRLA/GRLZ-M5: Brass |
| - | Seals | NBR |
| Note on materials | | RoHS-compliant |

Dimensions

Slotted head screw

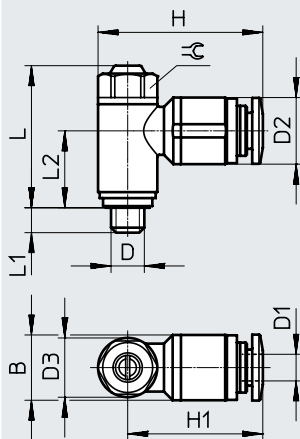

Knurled screw

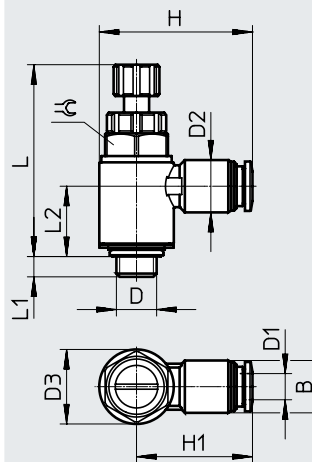

Download CAD data → www.festo.com

| Type | Connection D | Tubing O.D. D1 | B | D2 ø | D3 ø | ~H | ~H1 | ~L | | L1 | ~L2 | ⊕ |
|-----------------|-----------------|-------------------|-----------|------------|------------|------|------|--------------------|---------------|--------------------|-------|----|
| | | | | | | | | Slotted head screw | Knurled screw | | | |
| GRL...-M5 | M5 | 3 | - | 8.2 +0.15 | 8.9 ±0.07 | 22.4 | 18 | 20.8 ±3.3% | 31.5 ±2.4% | 3.9 +0.1/-0.45 | 10.7 | 8 |
| | | 4 | 9.8 ±0.2 | 10.0 ±0.2 | | 24.7 | 20.3 | | | | 9.7 | |
| | | 6 | - | 12.0 ±0.2 | | 26.5 | 22 | | | | | |
| GRL...-1/8 | G1/8 | 3 | - | 10.2 ±0.2 | 13.8 ±0.07 | 31.9 | 25 | 26.5 ±2.1% | 40.4 ±1.6% | 5.05 +0.15/-0.3 | 14.2 | 12 |
| | | 4 | | 10.2 ±0.2 | | 29.4 | 22.5 | | | | 13.5 | |
| | | 6 | | 12.5 ±0.2 | | 32.6 | 25.7 | | | | | |
| GRLA-1/8-...-MF | G1/8 | 8 | - | 14.5 ±0.2 | 17.8 ±0.15 | 35.6 | 28.7 | 30.9 ±1.9% | - | 5.05 +0.15/-0.3 | 17 | 15 |
| | | 6 | 12.5 ±0.2 | 36.6 | | 27.7 | | | | | | |
| GRLA-1/4 | G1/4 | 6 | - | 12.5 ±0.2 | 17.8 ±0.15 | 36.6 | 27.7 | 31.5 ±1.9% | 48.5 ±1.4% | 5.9 +0.17/-0.25 | 17.2 | 15 |
| | | 8 | | 14.5 ±0.2 | | 39.6 | 30.7 | | | | 16.1 | |
| | | 10 | | 17.5 ±0.2 | | 42.0 | 33.1 | | | | | |
| GRLA-3/8 | G3/8 | 6 | - | 12.5 ±0.2 | 22.4 ±0.15 | 39.8 | 28.6 | 35.3 ±1.7% | 55 ±1.3% | 6.9 +0.15/-0.3 | 19.55 | 19 |
| | | 8 | | 14.5 ±0.2 | | 44.1 | 32.9 | | | | | |
| | | 10 | | 17.5 ±0.2 | | 46.7 | 35.5 | | | | | |
| GRLA-1/2 | G1/2 | 12 | - | 20.5 ±0.15 | 27.8 ±0.15 | 55.3 | 41.4 | 42.6 ±1.4% | 65.9 ±1.1% | 8.35 +0.15/-0.3 | 22.75 | 24 |

Datasheet – Push-in connector QS, metal

★ Core Range

Ordering data – Exhaust air one-way flow control function

| Pneumatic connection | | Standard nominal flow rate qnN At 6 → 5 bar | | Standard flow rate qn At 6 → 0 bar | | Weight [g] | Part no. | Type |
|----------------------|---|--|-------------------------|---------------------------------------|-------------------------|---------------|----------|------|
| | | In flow control direction | In non-return direction | In flow control direction | In non-return direction | | | |
| 2 | 1 | [l/min] | [l/min] | [l/min] | [l/min] | | | |

Slotted head screw



| | | | | | | | | | |
|------|-------|-------|--------------|-------------|---------------|-------------|----------|------------------|--------------------|
| M5 | QS-3 | 100 | 60 ... 100 | 145 | 150 ... 170 | 13 | ★ 193137 | GRLA-M5-QS-3-D | |
| | QS-4 | 110 | 65 ... 110 | 165 | 140 ... 160 | | ★ 193138 | GRLA-M5-QS-4-D | |
| | QS-6 | 115 | 70 ... 110 | 185 | 145 ... 170 | | ★ 193139 | GRLA-M5-QS-6-D | |
| | G1/8 | QS-3 | 130 | 100 ... 130 | 180 | 200 ... 220 | 22 | ★ 193142 | GRLA-1/8-QS-3-D |
| | | QS-4 | 160 | 120 ... 190 | 250 | 270 ... 300 | | ★ 193143 | GRLA-1/8-QS-4-D |
| | | QS-6 | 185 | 160 ... 240 | 370 | 330 ... 390 | | ★ 193144 | GRLA-1/8-QS-6-D |
| | | QS-8 | 400 | 290 ... 420 | 600 | 570 ... 680 | 32 | ★ 537075 | GRLA-1/8-QS-6-MF-D |
| | | | 215 | 175 ... 250 | 400 | 330 ... 410 | 22 | ★ 193145 | GRLA-1/8-QS-8-D |
| | | | 475 | 325 ... 500 | 720 | 610 ... 760 | 32 | ★ 537076 | GRLA-1/8-QS-8-MF-D |
| | G1/4 | QS-6 | 400 | 290 ... 420 | 600 | 570 ... 680 | 42 | ★ 193146 | GRLA-1/4-QS-6-D |
| | | QS-8 | 475 | 325 ... 500 | 720 | 610 ... 760 | | ★ 193147 | GRLA-1/4-QS-8-D |
| | | QS-10 | 480 | 345 ... 500 | 760 | 630 ... 790 | | ★ 193148 | GRLA-1/4-QS-10-D |
| G3/8 | QS-6 | 495 | 320 ... 495 | 740 | 840 ... 890 | 60 | ★ 193149 | GRLA-3/8-QS-6-D | |
| | QS-8 | 820 | 450 ... 850 | 1300 | 1080 ... 1420 | | ★ 193150 | GRLA-3/8-QS-8-D | |
| | QS-10 | 900 | 540 ... 975 | 1400 | 1160 ... 1620 | | ★ 193151 | GRLA-3/8-QS-10-D | |
| G1/2 | QS-12 | 1580 | 925 ... 1605 | 2220 | 1910 ... 2500 | 106 | ★ 193152 | GRLA-1/2-QS-12-D | |

Knurled screw



| | | | | | | | | | | |
|-------|-------|------|--------------|-------------|---------------|---------------|-------------|---------------------|---------------------|--------------------|
| M5 | QS-3 | 100 | 60 ... 100 | 145 | 150 ... 170 | 14 | ★ 197576 | GRLA-M5-QS-3-RS-D | | |
| | QS-4 | 110 | 65 ... 110 | 165 | 140 ... 160 | | ★ 197577 | GRLA-M5-QS-4-RS-D | | |
| | QS-6 | 115 | 70 ... 110 | 185 | 145 ... 170 | | ★ 197578 | GRLA-M5-QS-6-RS-D | | |
| | G1/8 | QS-3 | 130 | 100 ... 130 | 180 | 200 ... 220 | 23 | ★ 197579 | GRLA-1/8-QS-3-RS-D | |
| | | QS-4 | 160 | 120 ... 190 | 250 | 270 ... 300 | | ★ 197580 | GRLA-1/8-QS-4-RS-D | |
| | | QS-6 | 185 | 160 ... 240 | 370 | 330 ... 390 | | ★ 197581 | GRLA-1/8-QS-6-RS-D | |
| | QS-8 | 215 | 175 ... 250 | 400 | 330 ... 410 | 24 | ★ 534337 | GRLA-1/8-QS-8-RS-D | | |
| | | G1/4 | QS-6 | 400 | 290 ... 420 | 600 | 570 ... 680 | 50 | ★ 534338 | GRLA-1/4-QS-6-RS-D |
| | | | QS-8 | 475 | 325 ... 500 | 720 | 610 ... 760 | | ★ 534339 | GRLA-1/4-QS-8-RS-D |
| | QS-10 | | 480 | 345 ... 500 | 760 | 630 ... 790 | ★ 534340 | | GRLA-1/4-QS-10-RS-D | |
| | G3/8 | QS-6 | 495 | 320 ... 495 | 740 | 840 ... 890 | 72 | ★ 534341 | GRLA-3/8-QS-6-RS-D | |
| | | QS-8 | 820 | 450 ... 850 | 1300 | 1080 ... 1420 | | ★ 534342 | GRLA-3/8-QS-8-RS-D | |
| QS-10 | | 900 | 540 ... 975 | 1400 | 1160 ... 1620 | ★ 534343 | | GRLA-3/8-QS-10-RS-D | | |
| G1/2 | QS-12 | 1580 | 925 ... 1605 | 2220 | 1910 ... 2500 | 124 | ★ 534344 | GRLA-1/2-QS-12-RS-D | | |

Ordering data – Supply air one-way flow control function

| Pneumatic connection | | Standard nominal flow rate qnN At 6 → 5 bar | | Standard flow rate qn At 6 → 0 bar | | Weight [g] | Part no. | Type |
|----------------------|---|--|-------------------------|---------------------------------------|-------------------------|---------------|----------|------|
| | | In flow control direction | In non-return direction | In flow control direction | In non-return direction | | | |
| 2 | 1 | [l/min] | [l/min] | [l/min] | [l/min] | | | |

Slotted head screw



| | | | | | | | | | |
|------|------|-------------|------------|-------------|-------------|-----------------|----------|----------------|-----------------|
| M5 | QS-3 | 100 | 60 ... 100 | 135 | 130 ... 160 | 13 | ★ 193153 | GRLZ-M5-QS-3-D | |
| | QS-4 | 110 | 65 ... 110 | 160 | 150 ... 180 | | ★ 193154 | GRLZ-M5-QS-4-D | |
| | QS-6 | 115 | 70 ... 110 | 170 | 160 ... 200 | | ★ 193155 | GRLZ-M5-QS-6-D | |
| | G1/8 | QS-3 | 130 | 100 ... 130 | 200 | 180 ... 200 | 22 | ★ 193156 | GRLZ-1/8-QS-3-D |
| | | QS-4 | 160 | 120 ... 190 | 300 | 260 ... 290 | | ★ 193157 | GRLZ-1/8-QS-4-D |
| | | QS-6 | 185 | 160 ... 240 | 340 | 390 ... 460 | | ★ 193158 | GRLZ-1/8-QS-6-D |
| QS-8 | 215 | 175 ... 250 | 370 | 390 ... 470 | ★ 193159 | GRLZ-1/8-QS-8-D | | | |

Datasheet – Female thread/barbed connector, metal

One-way flow control function

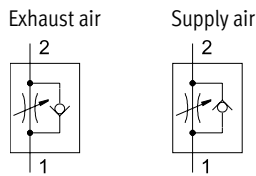

- - Flow rate
83 ... 4320 l/min
- - Temperature range
-10 ... +60°C
- - Operating pressure
0.2 ... 10 bar



GRLA/GRLZ

GRLA/GRLZ-...-RS

GRLA/GRLZ-...-PK

General technical data – GRLA

| Connection type | Female thread | | | | | | Barbed connector | | |
|-----------------------------|---|--------------------|--------------------|--------------------|--------------------|--------------------|------------------|------------------|------------|
| | Pneumatic connection 2 | M5 | G1/8 | G1/4 | G3/8 | G1/2 | G3/4 | M5 | G1/8 |
| Pneumatic connection 1 | M5 ¹⁾ | G1/8 ¹⁾ | G1/4 ¹⁾ | G3/8 ¹⁾ | G1/2 ¹⁾ | G3/4 ¹⁾ | PK-3, PK-4 | PK-3, PK-4, PK-6 | PK-4, PK-6 |
| Valve function | Exhaust air one-way flow control function | | | | | | | | |
| Adjusting element | Slotted head screw | | | | | | | | |
| | Knurled screw | | | | | | | | |
| Type of mounting | Screw-in | | | | | | | | |
| Mounting position | Any | | | | | | | | |
| Max. tightening torque [Nm] | 1.5 | 6 | 11 | 20 | 40 | 60 | 1.5 | 6 | 11 |

1) - Note: This product conforms to ISO 1179-1 and ISO 228-1.

General technical data – GRLZ

| Connection type | Female thread | | | Barbed connector | | |
|-----------------------------|--|--------------------|--------------------|------------------|------------------|------------|
| | Pneumatic connection 2 | M5 | G1/8 | G1/4 | M5 | G1/8 |
| Pneumatic connection 1 | M5 ¹⁾ | G1/8 ¹⁾ | G1/4 ¹⁾ | PK-3, PK-4 | PK-3, PK-4, PK-6 | PK-4, PK-6 |
| Valve function | Supply air one-way flow control function | | | | | |
| Adjusting element | Slotted head screw | | | | | |
| | Knurled screw | | | | | |
| Type of mounting | Screw-in | | | | | |
| Mounting position | Any | | | | | |
| Max. tightening torque [Nm] | 1.5 | 6 | 11 | 1.5 | 6 | 11 |

1) - Note: This product conforms to ISO 1179-1 and ISO 228-1.

Operating and environmental conditions

| Pneumatic connection 2 | M5 | G1/8 | G1/4 | G3/8 | G1/2 | G3/4 |
|---|--|------|------------|------|------|------|
| Operating pressure for full temperature range [bar] | 0.2 ... 10 | | 0.3 ... 10 | | | |
| Operating medium | Compressed air to ISO 8573-1:2010 [7:4:4] | | | | | |
| Note on the operating/pilot medium | Lubricated operation possible (required for further operation) | | | | | |
| Ambient temperature [°C] | -10 ... +60 | | | | | |
| Temperature of medium [°C] | -10 ... +60 | | | | | |
| Storage temperature [°C] | -10 ... +40 | | | | | |
| Maritime classification | GRLA: see certificate ¹⁾ | | | | | |

 1) Additional information: www.festo.com/catalogue/grla → Support/Downloads

Datasheet – Female thread/barbed connector, metal

Standard nominal flow rate q_{nN} at 6 → 5 bar as a function of spindle rotations n

GRLA/GRLZ-M5

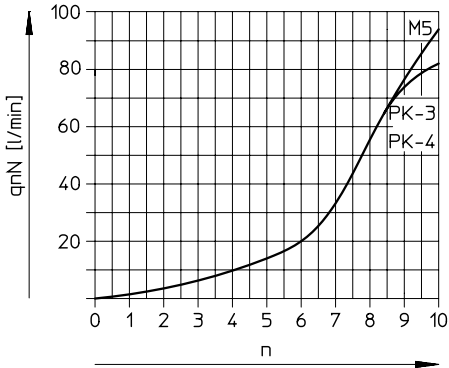

Standard flow rate q_n at 6 → 0 bar as a function of spindle rotations n

GRLA/GRLZ-M5

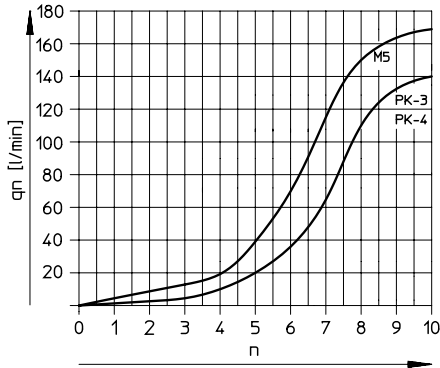

GRLA/GRLZ-1/8

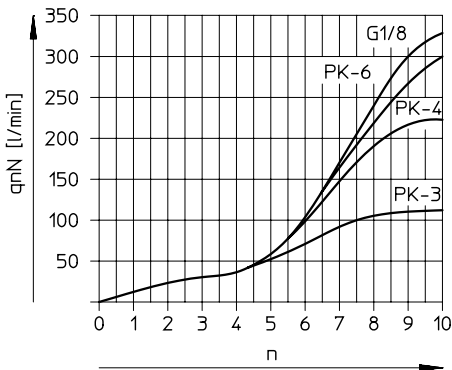

GRLA/GRLZ-1/8

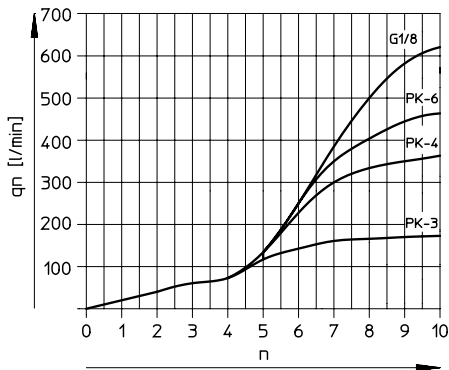

GRLA/GRLZ-1/4

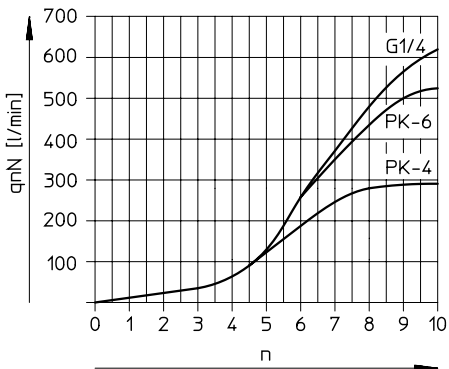

GRLA/GRLZ-1/4

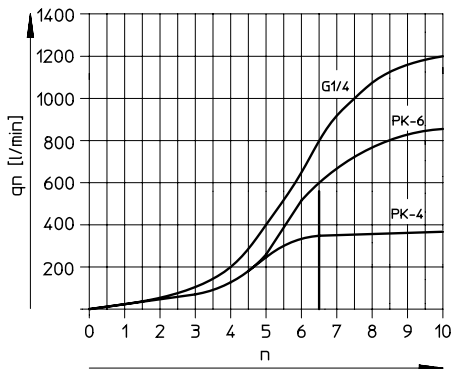

Datasheet – Female thread/barbed connector, metal

Standard nominal flow rate q_{nN} at 6 → 5 bar as a function of spindle rotations n

GRLA-3/8

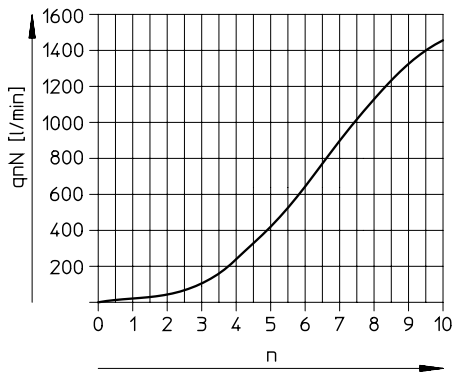

GRLA-1/2

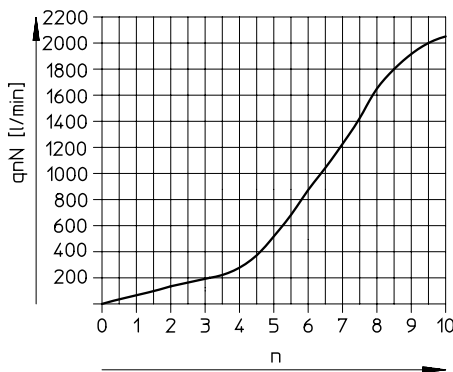

GRLA-3/4

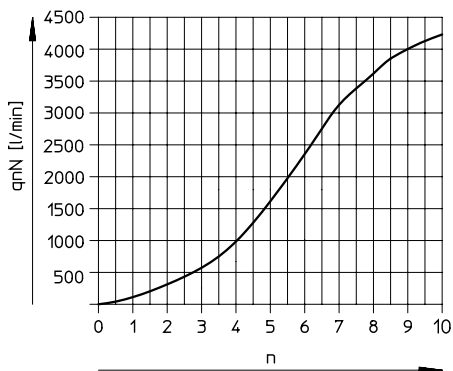

Standard flow rate q_n at 6 → 0 bar as a function of spindle rotations n

GRLA-3/8

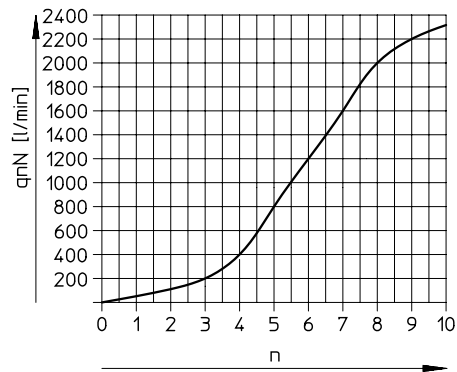

GRLA-1/2

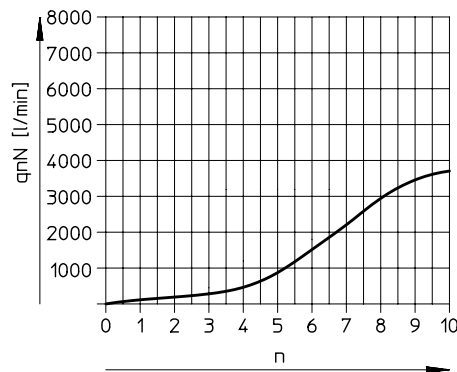

GRLA-3/4

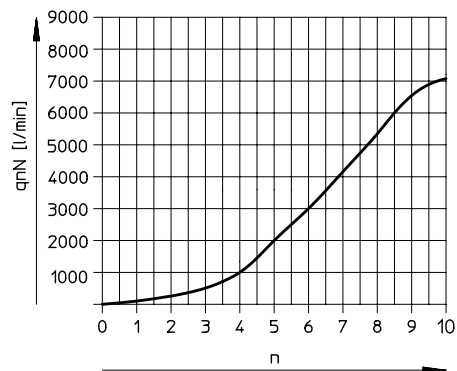

Materials

Sectional view

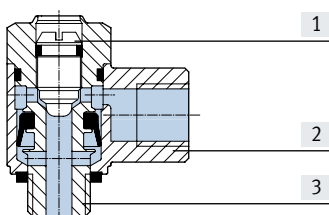

| One-way flow control valve | |
|----------------------------|--|
| [1] Adjusting screw | Brass |
| [2] Swivel joint | Die-cast zinc |
| [3] Screwed trunnion | Wrought aluminium alloy GRLA/GRLZ-M5: Nickel-plated brass |
| – Seals | NBR |
| Note on materials | RoHS-compliant |

Datasheet – Female thread/barbed connector, metal

Dimensions – Connection type: Female thread

Download CAD data → www.festo.com

Slotted head screw

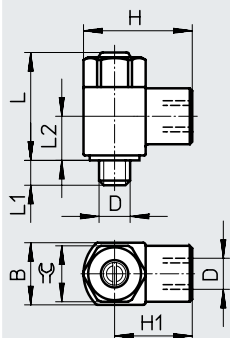

Knurled screw

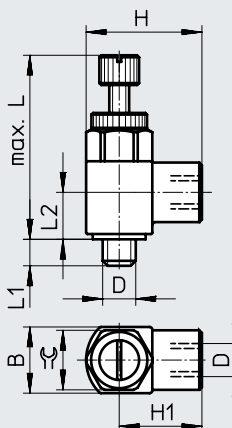

| Type | Connection D | Nominal size [mm] | B | ~H | ~H1 | ~L | | L1 | ~L2 | ⌀ |
|------------|--------------|-------------------|----------|------|------|--------------------|---------------|-----------------|------|----|
| | | | | | | Slotted head screw | Knurled screw | | | |
| GRL...-M5 | M5 | 2 | 10 -0.15 | 17.5 | 12.5 | 18 ±6.2% | 28 ±3.4% | 4.0 ±0.3 | 7.1 | 9 |
| GRL...-1/8 | G1/8 | 4 | 16 -0.15 | 28 | 20 | 26 ±3.9% | 39.4 ±2.1% | 5.3 +0.45/-0.35 | 10.3 | 14 |
| GRL...-1/4 | G1/4 | 6 | 20 -0.2 | 36 | 26 | 31.7 ±3.2% | 47.4 ±2.0% | 8.2 +0.45/-0.35 | 13.2 | 17 |
| GRLA-3/8 | G3/8 | 8.5 | 25 -0.2 | 41 | 28.5 | 38.5 ±2.9% | - | 8.8 +0.45/-0.35 | 15.5 | 22 |
| GRLA-1/2 | G1/2 | 10.6 | 32 -0.2 | 53 | 37 | 50 ±2.4% | - | 12.8 ±0.45 | 18.9 | 27 |
| GRLA-3/4 | G3/4 | 14 | 41 -0.3 | 64 | 43.5 | 61.8 ±2.2% | - | 13.5 ±0.5 | 24.5 | 36 |

† Note: This product conforms to ISO 1179-1 and ISO 228-1.

Dimensions – Connection type: Barbed connector

Download CAD data → www.festo.com

GRL...-M5

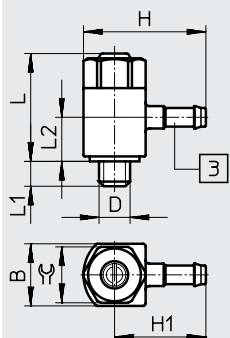

[3] Barbed connector

GRL...-1/8, GRL...-1/4

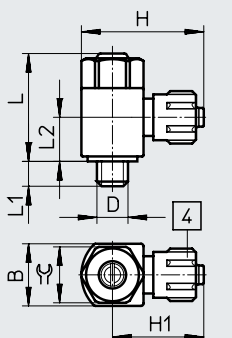

[4] Union nut

| Type | Connection D | Nominal size [mm] | B | ~H | ~H1 | ~L | | L1 | ~L2 | ⌀ |
|-----------------|--------------|-------------------|----------|------|------|------|-------|-----------------|------|----|
| GRL...-M5-PK-3 | M5 | 2 | 10 -0.15 | 19.7 | 14.7 | 18 | ±5.7% | 4.0 ±0.3 | 8.5 | 9 |
| GRL...-M5-PK-4 | | | 10 -0.15 | 21.7 | 16.7 | 18 | ±5.7% | 4.0 ±0.3 | 8.5 | 9 |
| GRL...-1/8-PK-3 | G1/8 | 4 | 16 -0.15 | 27.1 | 19.1 | 26 | ±3.9% | 5.3 +0.45/-0.35 | 13.4 | 14 |
| GRL...-1/8-PK-4 | | | 16 -0.15 | 30.2 | 22.2 | 26 | ±3.9% | 5.3 +0.45/-0.35 | 13.4 | 14 |
| GRL...-1/8-PK-6 | | | 16 -0.15 | 30.3 | 22.3 | 26 | ±3.9% | 5.3 +0.45/-0.35 | 12.0 | 14 |
| GRL...-1/4-PK-4 | G1/4 | 6 | 20 -0.2 | 34.2 | 24.2 | 31.7 | ±3.3% | 8.2 +0.45/-0.35 | 16.9 | 17 |
| GRL...-1/4-PK-6 | | | 20 -0.2 | 34.3 | 24.3 | 31.7 | ±3.3% | 8.2 +0.45/-0.35 | 17.2 | 17 |

Datasheet – Female thread/barbed connector, metal

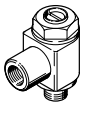
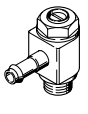
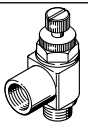
| Ordering data – Exhaust air one-way flow control function | | | | | | | | | |
|--|----------------------|--------------------|--|-------------------------|---------------------------------------|-------------------------|---------------|----------|-----------------|
| | Pneumatic connection | | Standard nominal flow rate qnN At 6 → 5 bar | | Standard flow rate qn At 6 → 0 bar | | Weight [g] | Part no. | Type |
| | | | In flow control direction | In non-return direction | In flow control direction | In non-return direction | | | |
| | 2 | 1 | [l/min] | [l/min] | [l/min] | [l/min] | | | |
| Slotted head screw | | | | | | | | | |
|  | M5 | M5 | 95 | 76 ... 95 | 169 | 135 ... 170 | 11 | 151160 | GRLA-M5-B |
| | G1/8 | G1/8 | 340 | 260 ... 420 | 615 | 470 ... 760 | 28 | 151165 | GRLA-1/8-B |
| | G1/4 ²⁾ | G1/4 ³⁾ | 610 | 450 ... 820 | 1200 | 885 ... 1615 | 59 | 151172 | GRLA-1/4-B |
| | G3/8 | G3/8 | 1450 | 970 ... 1600 | 2300 | 1540 ... 2540 | 97 | 151178 | GRLA-3/8-B |
| | G1/2 | G1/2 | 2100 | 1550 ... 2200 | 4000 | 2950 ... 4190 | 204 | 151179 | GRLA-1/2-B |
| | G3/4 | G3/4 | 4320 | 3220 ... 4720 | 7300 | 5440 ... 7300 | 377 | 151180 | GRLA-3/4-B |
|  | M5 | PK-3 | 83 | 72 ... 83 | 140 | 120 ... 140 | 10 | 151161 | GRLA-M5-PK-3-B |
| | | PK-4 | 83 | 76 ... 88 | 140 | 128 ... 148 | 10 | 151162 | GRLA-M5-PK-4-B |
| | G1/8 | PK-3 ¹⁾ | 110 | 100 ... 110 | 162 | 145 ... 165 | 22 | 151166 | GRLA-1/8-PK-3-B |
| | | PK-4 ¹⁾ | 230 | 190 ... 240 | 360 | 295 ... 375 | 25 | 151167 | GRLA-1/8-PK-4-B |
| | | PK-6 ¹⁾ | 300 | 210 ... 290 | 455 | 320 ... 440 | 26 | 151168 | GRLA-1/8-PK-6-B |
| | G1/4 ²⁾ | PK-4 ⁴⁾ | 260 | 220 ... 260 | 370 | 315 ... 370 | 44 | 151173 | GRLA-1/4-PK-4-B |
| | | PK-6 ⁴⁾ | 540 | 410 ... 585 | 840 | 635 ... 910 | 45 | 151174 | GRLA-1/4-PK-6-B |
| | Knurled screw | | | | | | | | |
|  | M5 | M5 | 95 | 76 ... 95 | 169 | 135 ... 170 | 12 | 151163 | GRLA-M5-RS-B |
| | G1/8 | G1/8 | 340 | 260 ... 420 | 615 | 470 ... 760 | 30 | 151169 | GRLA-1/8-RS-B |
| | G1/4 ²⁾ | G1/4 ³⁾ | 610 | 450 ... 820 | 1200 | 885 ... 1615 | 59 | 151175 | GRLA-1/4-RS-B |

- 1) Via union nut
- 2) Male thread
- 3) Female thread
- 4) For barbed connector internal diameter with union nut

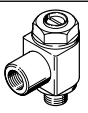
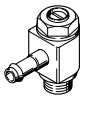
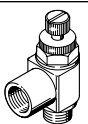

| Ordering data – Supply air one-way flow control function | | | | | | | | | |
|---|----------------------|--------------------|--|-------------------------|---------------------------------------|-------------------------|---------------|----------|-----------------|
| | Pneumatic connection | | Standard nominal flow rate qnN At 6 → 5 bar | | Standard flow rate qn At 6 → 0 bar | | Weight [g] | Part no. | Type |
| | | | In flow control direction | In non-return direction | In flow control direction | In non-return direction | | | |
| | 2 | 1 | [l/min] | [l/min] | [l/min] | [l/min] | | | |
| Slotted head screw | | | | | | | | | |
|  | M5 | M5 | 95 | 76 ... 95 | 169 | 135 ... 170 | 11 | 151183 | GRLZ-M5-B |
| | G1/8 | G1/8 | 340 | 260 ... 420 | 615 | 470 ... 760 | 28 | 151188 | GRLZ-1/8-B |
| | G1/4 ²⁾ | G1/4 ³⁾ | 610 | 450 ... 820 | 1200 | 885 ... 1615 | 59 | 151195 | GRLZ-1/4-B |
|  | M5 | PK-3 | 83 | 72 ... 83 | 140 | 120 ... 140 | 10 | 151184 | GRLZ-M5-PK-3-B |
| | | PK-4 | 83 | 76 ... 88 | 140 | 125 ... 150 | 10 | 151185 | GRLZ-M5-PK-4-B |
| | G1/8 | PK-3 ¹⁾ | 110 | 100 ... 110 | 162 | 145 ... 165 | 22 | 151189 | GRLZ-1/8-PK-3-B |
| | | PK-4 ¹⁾ | 230 | 190 ... 240 | 360 | 295 ... 375 | 25 | 151190 | GRLZ-1/8-PK-4-B |
| | | PK-6 ¹⁾ | 300 | 210 ... 290 | 455 | 320 ... 440 | 26 | 151191 | GRLZ-1/8-PK-6-B |
| | G1/4 ²⁾ | PK-4 ⁴⁾ | 260 | 220 ... 260 | 370 | 315 ... 370 | 44 | 151196 | GRLZ-1/4-PK-4-B |
| | | PK-6 ⁴⁾ | 540 | 410 ... 585 | 840 | 635 ... 910 | 45 | 151197 | GRLZ-1/4-PK-6-B |
| | Knurled screw | | | | | | | | |
|  | M5 | M5 | 95 | 76 ... 95 | 169 | 135 ... 170 | 12 | 151186 | GRLZ-M5-RS-B |
| | G1/8 | G1/8 | 340 | 260 ... 420 | 615 | 470 ... 760 | 30 | 151192 | GRLZ-1/8-RS-B |
| | G1/4 ²⁾ | G1/4 ³⁾ | 610 | 450 ... 820 | 1200 | 885 ... 1615 | 59 | 151198 | GRLZ-1/4-RS-B |

- 1) Via union nut
- 2) Male thread
- 3) Female thread
- 4) For barbed connector internal diameter with union nut

Datasheet – Push-in connector QS, metal

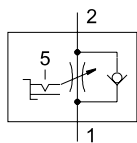
One-way flow control function
Exhaust air



-  - Flow rate
0 ... 450 l/min
-  - Temperature range
-10 ... +60°C
-  - Operating pressure
0.2 ... 10 bar



This one-way flow control valve provides the perfect conditions and a unique design for optimum and easy setting of the flow rate.

There are two setting options:

[1] Gradual for preselecting the flow rate range in 5 steps using a rotary switch: A, B, C, D, E

[2] Infinitely variable for precision adjustment with a hex key using a scale marked from 0 to 10

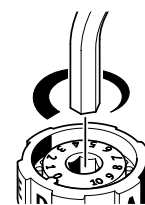
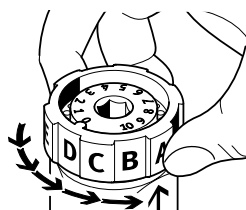
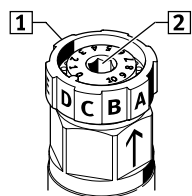

| General technical data | | |
|--------------------------------|---|---------|
| Pneumatic connection 2 | G1/8 | G1/4 |
| Pneumatic connection 1 | QS-6 | QS-8 |
| Valve function | Exhaust air one-way flow control function | |
| Adjusting element | Rotary knob with scale and hex socket | |
| Actuation type | Manual | |
| Type of mounting | Screw-in | |
| Mounting position | Any | |
| Nominal tightening torque [Nm] | 3.5 ±20% | 11 ±10% |

| Operating and environmental conditions | | |
|---|--|--|
| Operating pressure for full temperature range [bar] | 0.2 ... 10 | |
| Operating medium | Compressed air to ISO 8573-1:2010 [7:4:4] | |
| Note on the operating/pilot medium | Lubricated operation possible (required for further operation) | |
| Ambient temperature [°C] | -10 ... +60 | |
| Temperature of medium [°C] | -10 ... +60 | |
| Storage temperature [°C] | -10 ... +40 | |

Datasheet – Push-in connector QS, metal

Standard nominal flow rate q_{nN} at 6 → 5 bar as a function of the position of the flow control screw (scale) n

GRLSA-1/8

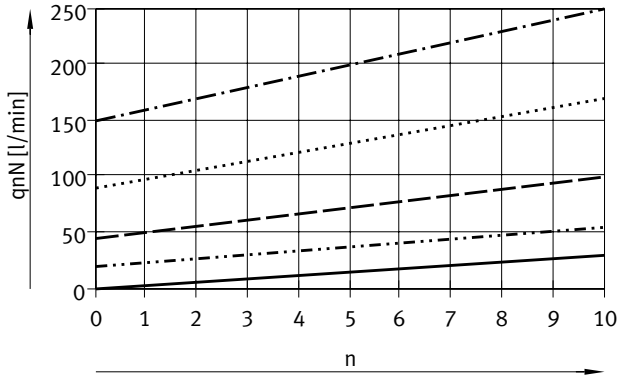

Standard flow rate q_n at 6 → 0 bar as a function of the position of the flow control screw (scale) n

GRLSA-1/8

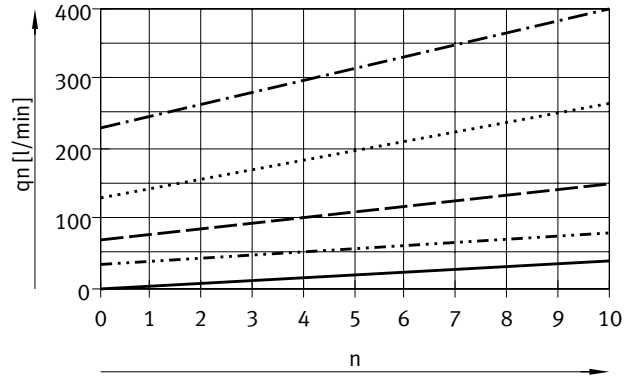

GRLSA-1/4

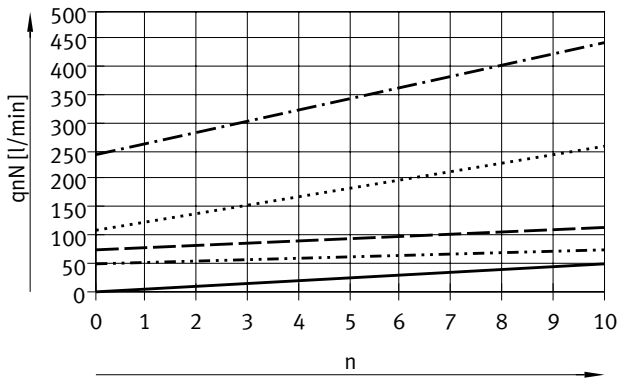

GRLSA-1/4

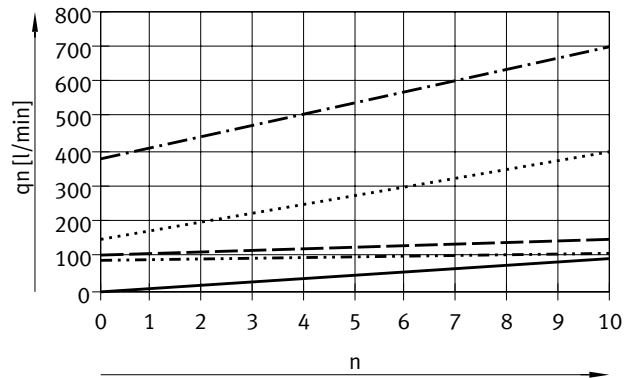

- Stage: A
 - · - · Stage: B
 - - - Stage: C
 - · · · · Stage: D
 - · - · - Stage: E
- Flow rate value tolerance: ±20%

Materials

Sectional view

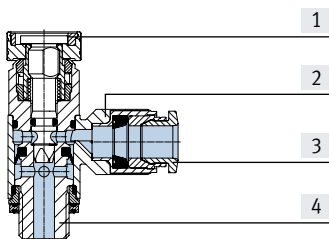

| One-way flow control valve | | |
|----------------------------|-----------------|----------------------------------|
| [1] | Adjusting screw | Reinforced PA |
| [2] | Swivel joint | Die-cast zinc |
| [3] | Releasing ring | POM |
| [4] | Hollow bolt | Anodised wrought aluminium alloy |
| - | Seals | NBR |
| Note on materials | | RoHS-compliant |
| | | Free of copper and PTFE |

Datasheet – Push-in connector QS, metal

Dimensions

Download CAD data → www.festo.com

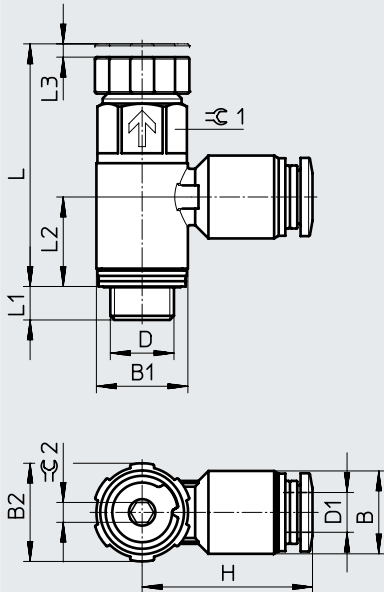

| Type | Connection D | Tubing O.D. D1 | B | B1 | B2 | H | L | L1 | L2 | L3 | ≈1 | ≈2 |
|-----------|--------------|----------------|------|------|------|-------|------|-----|------|----|----|----|
| GRLSA-1/8 | G1/8 | 6 | 12.5 | 13.8 | 15 | 25.7 | 36.6 | 5.1 | 13.5 | 2 | 12 | 3 |
| GRLSA-1/4 | G1/4 | 8 | 14.5 | 17.8 | 18.8 | 30.75 | 46.5 | 7 | 17.2 | 3 | 15 | 3 |

Ordering data



| | Pneumatic connection | | Standard nominal flow rate qnN At 6 → 5 bar | | Standard flow rate qn At 6 → 0 bar | | Weight [g] | Part no. | Type |
|--|----------------------|------|--|-------------------------|---------------------------------------|-------------------------|---------------|----------|----------------|
| | | | In flow control direction | In non-return direction | In flow control direction | In non-return direction | | | |
| | | | [l/min] | [l/min] | [l/min] | [l/min] | | | |
| | G1/8 | QS-6 | 0 ... 250 | 180 ... 310 | 0 ... 410 | 430 ... 540 | 19.5 | 540661 | GRLSA-1/8-QS-6 |
| | G1/4 | QS-8 | 0 ... 450 | 390 ... 570 | 0 ... 700 | 820 ... 930 | 34.8 | 540662 | GRLSA-1/4-QS-8 |

Datasheet – Push-in connector QS, polymer

One-way flow control function

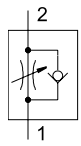
Exhaust air



-  - Flow rate
520 ... 650 l/min
-  - Temperature range
-10 ... +60°C
-  - Operating pressure
0.2 ... 10 bar



Can be rotated 360° around the screw-in axis after installation.

| General technical data | | | |
|---|---|------------|------------|
| Pneumatic connection 2 | G1/8 | G1/4 | G3/8 |
| Pneumatic connection 1 | QS-6, QS-8 | QS-6, QS-8 | QS-6, QS-8 |
| Valve function | Exhaust air one-way flow control function | | |
| Adjusting element | Knurled screw | | |
| Actuation type | Manual | | |
| Type of mounting | Screw-in | | |
| Mounting position | Any | | |
| Nominal tightening torque [Nm] | 3.5 ±20% | 11 ±10% | 12.5 ±20% |
| Permissible actuation torque for adjusting screw [Nm] | 0.4 | | |

| Operating and environmental conditions | |
|---|--|
| Operating pressure for full temperature range [bar] | 0.2 ... 10 |
| Operating medium | Compressed air to ISO 8573-1:2010 [7:4:4] |
| Note on the operating/pilot medium | Lubricated operation possible (required for further operation) |
| Ambient temperature [°C] | -10 ... +60 |
| Temperature of medium [°C] | -10 ... +60 |
| Storage temperature [°C] | -10 ... +40 |
| Corrosion resistance class CRC ¹⁾ | 2 |

1) Corrosion resistance class CRC 2 to Festo standard FN 940070

Moderate corrosion stress. Indoor applications in which condensation can occur. External visible parts with primarily decorative surface requirements that are in direct contact with a normal industrial environment.

Standard nominal flow rate q_{nN} at 6 → 5 bar as a function of spindle rotations n

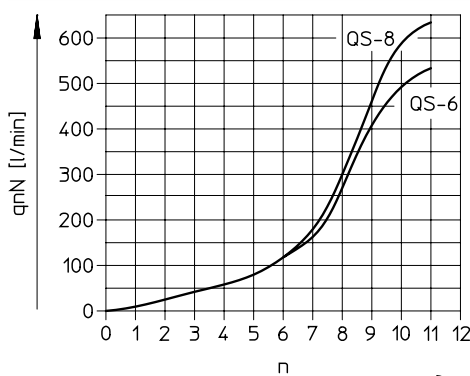

Standard flow rate q_n at 6 → 0 bar as a function of spindle rotations n

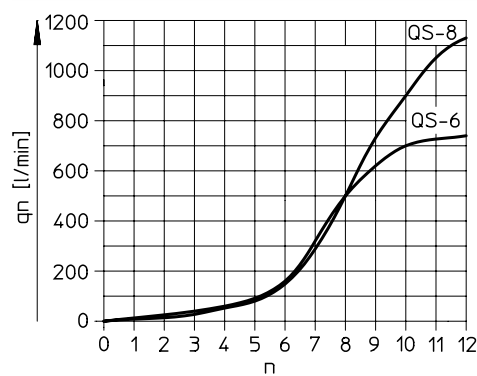

Datasheet – Push-in connector QS, polymer

Materials

Sectional view

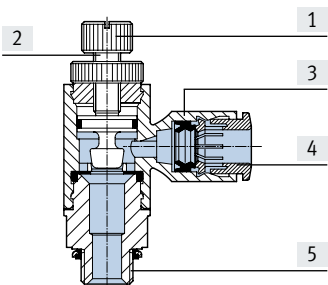

One-way flow control valve

| | | |
|-------------------|------------------|-------------------------|
| [1] | Knurled head | Wrought aluminium alloy |
| [2] | Adjusting screw | Brass |
| [3] | Swivel joint | Reinforced PBT |
| [4] | Releasing ring | POM |
| [5] | Screwed trunnion | Wrought aluminium alloy |
| - | Seals | TPE-U(PU), NBR |
| Note on materials | | RoHS-compliant |

Dimensions

Download CAD data → www.festo.com

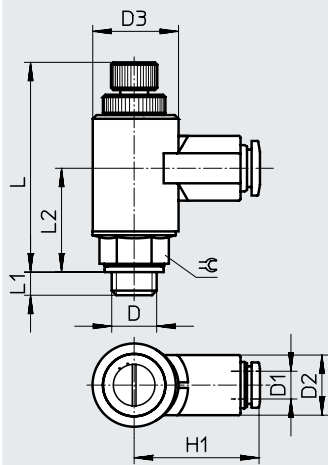

| Type | Connection | Tubing O.D. | D2 ø | D3 ø | ~H1 | ~L | ~L1 | ~L2 | ⊕ |
|----------|------------|-------------|------------|-----------|------|------------|-----|------|----|
| | D | D1 | | | | | | | |
| GRLA-1/8 | G1/8 | 6 | 13.0 ±0.25 | 17.9 -0.1 | 27.2 | 48.1 ±2.2% | 4.9 | 22.6 | 13 |
| | | 8 | 16.8 ±0.4 | | 35.4 | 48 ±2.3% | | | |
| GRLA-1/4 | G1/4 | 6 | 13.0 ±0.25 | 17.9 -0.1 | 27.2 | 47.8 ±2.3% | 5.8 | 22.3 | 17 |
| | | 8 | 16.8 ±0.4 | | 35.4 | 47.8 ±2.4% | | | |
| GRLA-3/8 | G3/8 | 6 | 13.0 ±0.25 | 17.9 -0.1 | 27.2 | 47.8 ±2.3% | 6.8 | 22.3 | 19 |
| | | 8 | 16.8 ±0.4 | | 35.4 | 47.8 ±2.4% | | | |

Ordering data

| | Pneumatic connection | | Standard nominal flow rate qnN | | Standard flow rate qn | | Weight [g] | Part no. | Type |
|---|----------------------|---------|--------------------------------|-------------------------|---------------------------|-------------------------|------------|----------|--------------------|
| | | | At 6 → 5 bar | | At 6 → 0 bar | | | | |
| | | | In flow control direction | In non-return direction | In flow control direction | In non-return direction | | | |
| 2 | 1 | [l/min] | [l/min] | [l/min] | [l/min] | | | | |
| | G1/8 | QS-6 | 520 | 400 ... 550 | 720 | 600 ... 750 | 25 | 162965 | GRLA-1/8-QS-6-RS-B |
| | | QS-8 | 650 | 600 ... 750 | 1080 | 800 ... 1250 | | 162966 | GRLA-1/8-QS-8-RS-B |
| | G1/4 | QS-6 | 520 | 400 ... 550 | 720 | 600 ... 750 | 30 | 162967 | GRLA-1/4-QS-6-RS-B |
| | | QS-8 | 650 | 600 ... 750 | 1130 | 800 ... 1250 | | 162968 | GRLA-1/4-QS-8-RS-B |
| | G3/8 | QS-6 | 530 | 400 ... 550 | 720 | 600 ... 750 | 40 | 162969 | GRLA-3/8-QS-6-RS-B |
| | | QS-8 | 650 | 600 ... 750 | 1130 | 800 ... 1250 | | 162970 | GRLA-3/8-QS-8-RS-B |



Datasheet – Push-in connector QS, metal

One-way flow control function

Exhaust air

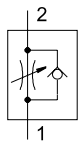
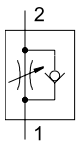
Supply air



-  - Flow rate
40 ... 48 l/min
-  - Temperature range
-10 ... +60°C
-  - Operating pressure
0.2 ... 10 bar

Low flow: precise adjustment
For low speed



| General technical data – GRLA | | |
|-------------------------------|---|------------|
| Pneumatic connection 2 | M3 | M5 |
| Pneumatic connection 1 | QS-3 | QS-3, QS-4 |
| Valve function | Exhaust air one-way flow control function | |
| Adjusting element | Slotted head screw | |
| Type of mounting | Screw-in | |
| Mounting position | Any | |
| Max. tightening torque [Nm] | 0.3 | 1.5 |

| General technical data – GRLZ | | |
|-------------------------------|--|------------|
| Pneumatic connection 2 | M3 | M5 |
| Pneumatic connection 1 | QS-3 | QS-3, QS-4 |
| Valve function | Supply air one-way flow control function | |
| Adjusting element | Slotted head screw | |
| Type of mounting | Screw-in | |
| Mounting position | Any | |
| Max. tightening torque [Nm] | 0.3 | 1.5 |

| Operating and environmental conditions | | |
|--|--|--|
| Operating pressure [bar] | 0.2 ... 10 | |
| Operating medium | Compressed air to ISO 8573-1:2010 [7:4:4] | |
| Note on the operating/pilot medium | Lubricated operation possible (required for further operation) | |
| Ambient temperature [°C] | -10 ... +60 | |
| Temperature of medium [°C] | -10 ... +60 | |
| Storage temperature [°C] | -10 ... +40 | |
| Maritime classification | GRLA: see certificate ¹⁾ | |

1) Additional information: www.festo.com/catalogue/grla → Support/Downloads

Datasheet – Push-in connector QS, metal

Standard nominal flow rate q_{nN} at 6 → 5 bar as a function of spindle rotations n

GRLA/GRLZ-M3

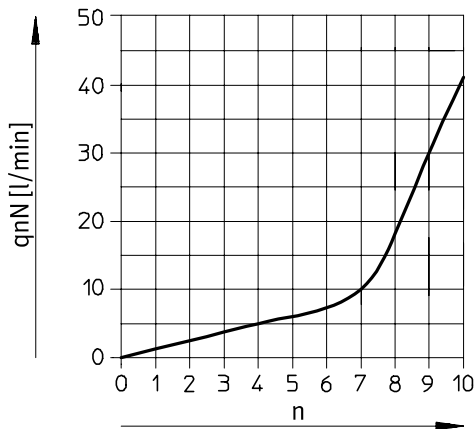

Standard flow rate q_n at 6 → 0 bar as a function of spindle rotations n

GRLA/GRLZ-M3

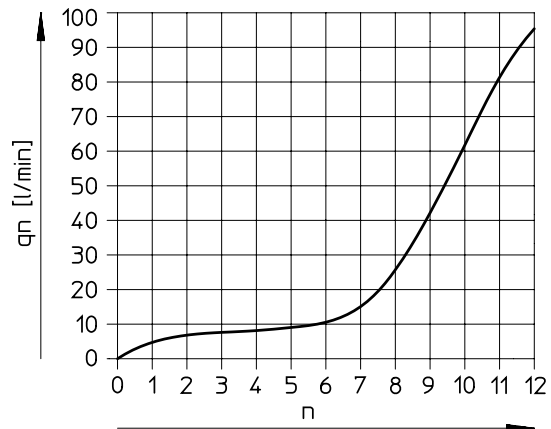

GRLA/GRLZ-M5

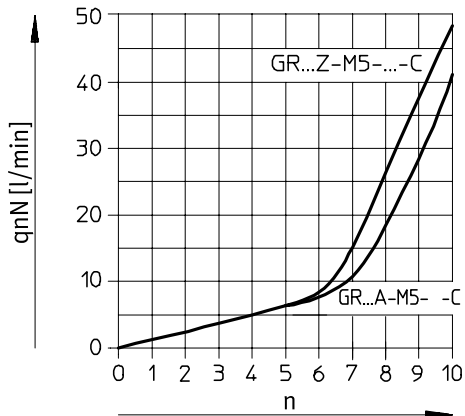

GRLA/GRLZ-M5

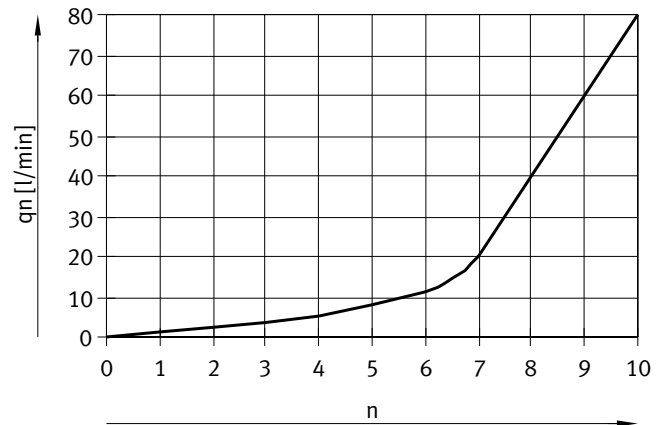

Materials

Sectional view

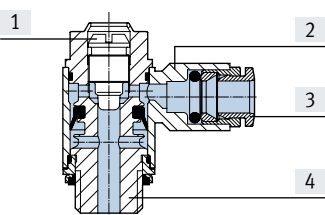

One-way flow control valve

| | | |
|-------------------|------------------|----------------------|
| [1] | Adjusting screw | Brass |
| [2] | Swivel joint | Die-cast zinc |
| [3] | Releasing ring | POM |
| [4] | Screwed trunnion | Brass, nickel-plated |
| - | Seals | NBR |
| Note on materials | | RoHS-compliant |

Datasheet – Push-in connector QS, metal

Dimensions

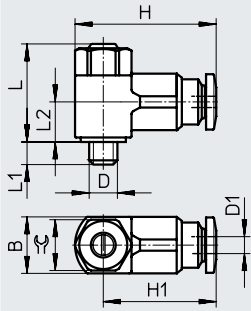
 Download CAD data → www.festo.com

| Type | Connection D | Nominal size [mm] | Tubing O.D. D1 | B | ~H | ~H1 | ~L | L1 | ~L2 | ≙ |
|-----------|-----------------|----------------------|-------------------|----------------------|------|------|------------|----------------------------|-----|---|
| GRLA/GRLZ | M3 | 1.4 | 3 | 8 ^{-0.15} | 20 | 15.8 | 16.6 ±3.3% | 2.3 ^{+0.15/-0.3} | 7 | 7 |
| | M5 | 1.4 | 3 | 9.8 ^{-0.15} | 22.4 | 18.4 | 17.2 ±3.1% | 3.1 ^{+0.15/-0.35} | 7.3 | |
| | | 1.4 | 4 | 9.8 ^{-0.15} | 22.2 | 18.2 | 17.2 ±3.1% | 3.1 ^{+0.15/-0.35} | 7.3 | |

Ordering data

| Pneumatic connection | Standard nominal flow rate qnN At 6 → 5 bar | | Standard flow rate qn At 6 → 0 bar | | Weight [g] | Part no. | Type |
|----------------------|--|-------------------------|---------------------------------------|-------------------------|---------------|----------|------|
| | In flow control direction | In non-return direction | In flow control direction | In non-return direction | | | |
| | 2 | 1 | [l/min] | [l/min] | | | |

Exhaust air one-way flow control function

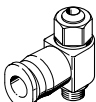
|  | Connection | Flow control | Nominal size | Standard nominal flow rate qnN | Standard flow rate qn | Weight | Part no. | Type | |
|---|------------|--------------|--------------|--------------------------------|-----------------------|------------|----------|-------------------|-------------------|
| | M3 | QS-3 | 41 | 27 ... 50 | 95 | 75 ... 110 | 7 | 175041 | GRLA-M3-QS-3 |
| | M5 | QS-3 | 40 | 46 ... 70 | 80 | 90 ... 140 | 9 | 175053 | GRLA-M5-QS-3-LF-C |
| QS-4 | | 40 | 50 ... 75 | 80 | 100 ... 150 | 9 | 175056 | GRLA-M5-QS-4-LF-C | |

Supply air one-way flow control function

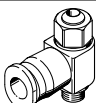
|  | Connection | Flow control | Nominal size | Standard nominal flow rate qnN | Standard flow rate qn | Weight | Part no. | Type | |
|---|------------|--------------|--------------|--------------------------------|-----------------------|------------|----------|-------------------|-------------------|
| | M3 | QS-3 | 41 | 27 ... 44 | 95 | 75 ... 100 | 7 | 175043 | GRLZ-M3-QS-3 |
| | M5 | QS-3 | 48 | 36 ... 52 | 80 | 60 ... 90 | 9 | 175055 | GRLZ-M5-QS-3-LF-C |
| QS-4 | | 48 | 40 ... 65 | 80 | 65 ... 110 | 9 | 175058 | GRLZ-M5-QS-4-LF-C | |



Datasheet – Female thread, metal

One-way flow control function

Exhaust air

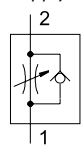
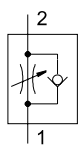
Supply air



-  - Flow rate
0 ... 18 l/min
-  - Temperature range
-10 ... +60°C
-  - Operating pressure
0.2 ... 10 bar



General technical data – GRLA

| | |
|-----------------------------|---|
| Pneumatic connection 2 | M3 |
| Pneumatic connection 1 | M3 |
| Valve function | Exhaust air one-way flow control function |
| Adjusting element | Slotted head screw |
| Type of mounting | Screw-in |
| Mounting position | Any |
| Max. tightening torque [Nm] | 0.3 |

General technical data – GRLZ

| | |
|-----------------------------|--|
| Pneumatic connection 2 | M3 |
| Pneumatic connection 1 | M3 |
| Valve function | Supply air one-way flow control function |
| Adjusting element | Slotted head screw |
| Type of mounting | Screw-in |
| Mounting position | Any |
| Max. tightening torque [Nm] | 0.3 |

Operating and environmental conditions

| | |
|------------------------------------|--|
| Operating pressure [bar] | 0.2 ... 10 |
| Operating medium | Compressed air to ISO 8573-1:2010 [7:4:4] |
| Note on the operating/pilot medium | Lubricated operation possible (required for further operation) |
| Ambient temperature [°C] | -10 ... +60 |
| Temperature of medium [°C] | -10 ... +60 |
| Storage temperature [°C] | -10 ... +40 |
| Maritime classification | GRLA: see certificate ¹⁾ |

1) Additional information: www.festo.com/catalogue/grla → Support/Downloads

Standard nominal flow rate q_{nN} at 6 → 5 bar as a function of spindle rotations n

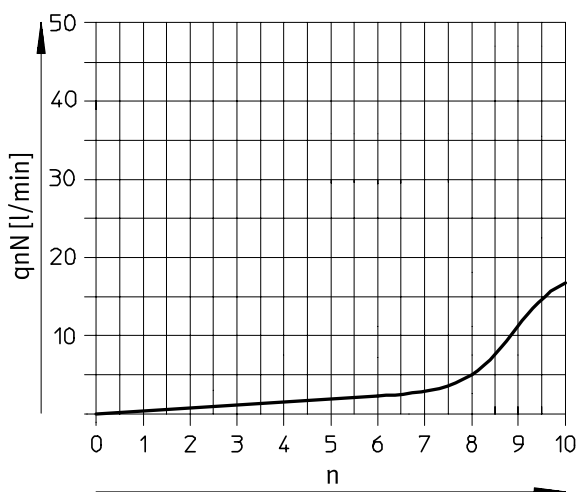

Standard flow rate q_n at 6 → 0 bar as a function of spindle rotations n

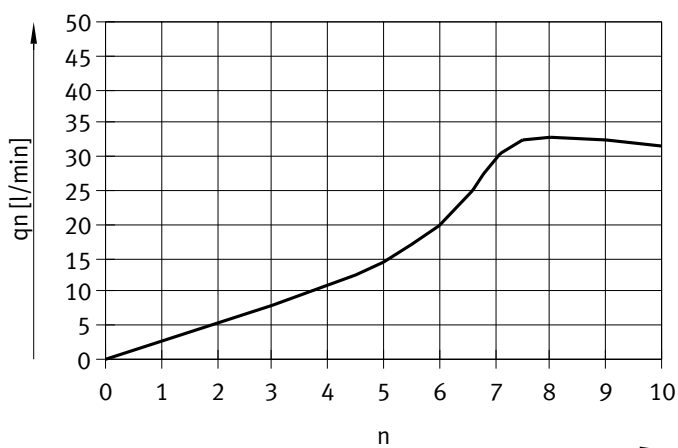

Datasheet – Female thread, metal

Materials

Sectional view

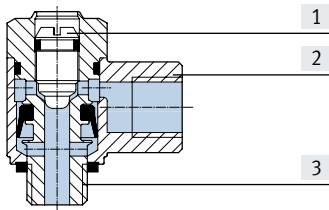

| | |
|----------------------------|----------------------|
| One-way flow control valve | |
| [1] Adjusting screw | Brass |
| [2] Swivel joint | Die-cast zinc |
| [3] Screwed trunnion | Brass, nickel-plated |
| - Seals | NBR |
| Note on materials | RoHS-compliant |

Dimensions

Download CAD data → www.festo.com

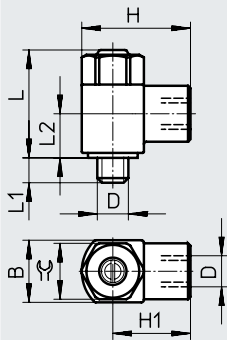

| Type | Connection D | Nominal size [mm] | B | ~H | ~H1 | ~L | L1 | ~L2 | ⌀ |
|-----------|--------------|-------------------|--------|----|-----|------------|----------------|-----|-----|
| GRLA/GRLZ | M3 | 0.8 | 5 -0.1 | 9 | 6.5 | 13.4 ±3.9% | 2.5 +0.15/-0.3 | 6.4 | 4.5 |

Ordering data



| Pneumatic connection | Standard nominal flow rate q _{nN} At 6 → 5 bar | | Standard flow rate q _n At 6 → 0 bar | | Weight [g] | Part no. | Type | | |
|--|--|-------------------------|---|-------------------------|------------|-----------|------|--------|---------|
| | In flow control direction | In non-return direction | In flow control direction | In non-return direction | | | | | |
| 2 1 | [l/min] | [l/min] | [l/min] | [l/min] | | | | | |
| Exhaust air one-way flow control function | | | | | | | | | |
| | M3 | M3 | 18 | 18 ... 20 | 33 | 33 ... 37 | 2 | 175038 | GRLA-M3 |
| Supply air one-way flow control function | | | | | | | | | |
| | M3 | M3 | 18 | 18 ... 20 | 33 | 33 ... 37 | 2 | 175040 | GRLZ-M3 |

Datasheet – Female thread, stainless steel

One-way flow control function

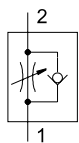
Exhaust air



-  Flow rate
95 ... 2100 l/min
-  Temperature range
-20 ... +80°C
-  Operating pressure
0.3 ... 10 bar



| General technical data | | | | | | |
|---|---|-----|------|------|------|------|
| Pneumatic connection 2 | | M5 | G1/8 | G1/4 | G3/8 | G1/2 |
| Pneumatic connection 1 | | M5 | G1/8 | G1/4 | G3/8 | G1/2 |
| Valve function | Exhaust air one-way flow control function | | | | | |
| Adjusting element | Slotted head screw | | | | | |
| Actuation type | Manual | | | | | |
| Type of mounting | Screw-in | | | | | |
| Mounting position | Any | | | | | |
| Rotatability | 360°/continuous rotation not permitted | | | | | |
| Max. tightening torque | [Nm] | 1.5 | 6 | 11 | 20 | 40 |
| Permissible actuation torque, adjusting screw | [Nm] | 0.2 | 0.5 | 1.5 | 2 | 3 |

† Note: This product conforms to ISO 1179-1 and ISO 228-1.

| Operating and environmental conditions | | | | | | |
|--|---|-------------|--------------|------|------|------|
| Pneumatic connection 2 | | M5 | G1/8 | G1/4 | G3/8 | G1/2 |
| Operating pressure | [MPa] | 0.02 ... 1 | 0.03 ... 1 | | | |
| | [bar] | 0.2 ... 10 | 0.3 ... 10 | | | |
| | [psi] | 2.9 ... 145 | 4.35 ... 145 | | | |
| Operating medium | Compressed air to ISO 8573-1:2010 [7:4:4] | | | | | |
| Note on the operating/pilot medium | Lubricated operation possible (in which case lubricated operation will always be required) | | | | | |
| LABS (PWIS) conformity | VDMA24364-B2-L | | | | | |
| Suitable for the production of lithium-ion batteries | Metals with more than 1% by mass of copper, zinc or nickel are excluded from use. Exceptions are nickel in steel, chemically nickel-plated surfaces, printed circuit boards, cables, electrical plug connectors and coils | | | | | |
| Cleanroom class | Element installed statically, no meaningful evaluation possible according to ISO 14644-1 | | | | | |
| Ambient temperature | [°C] | -20 ... +80 | | | | |
| Temperature of medium | [°C] | -10 ... +60 | | | | |
| Storage temperature | [°C] | -10 ... +40 | | | | |
| Corrosion resistance class CRC ¹⁾ | 3 | | | | | |
| Food-safe | See supplementary material information ²⁾ | | | | | |
| Maritime classification | See certificate ²⁾ | | | | | |

1) Corrosion resistance class CRC 3 to Festo standard FN 940070

High corrosion stress. Outdoor exposure under moderate corrosive conditions. External visible parts with primarily functional surface requirements that are in direct contact with a normal industrial environment.

2) Additional information: www.festo.com/catalogue/crgla → Support/Downloads.

Datasheet – Female thread, stainless steel

Standard nominal flow rate q_{nN} at 6 → 5 bar as a function of spindle rotations n

CRGRLA-M5, CRGRLA-1/8

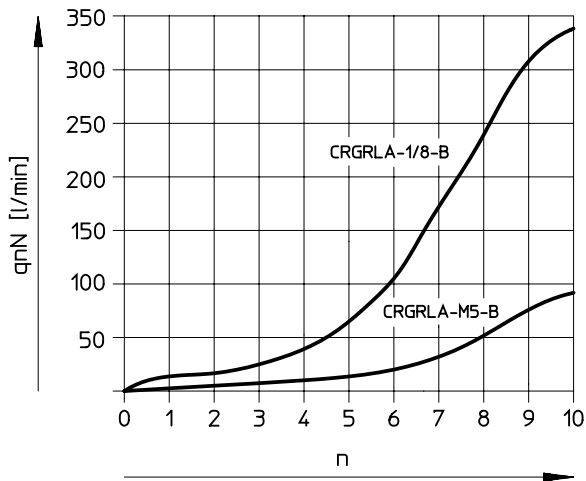

Standard flow rate q_n at 6 → 0 bar as a function of spindle rotations n

CRGRLA-M5, CRGRLA-1/8

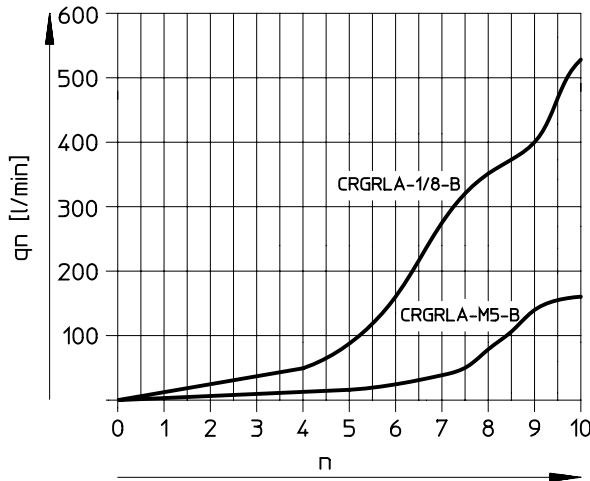

Standard nominal flow rate q_{nN} at 6 → 5 bar as a function of spindle rotations n

CRGRLA-1/4, CRGRLA-3/8, CRGRLA-1/2

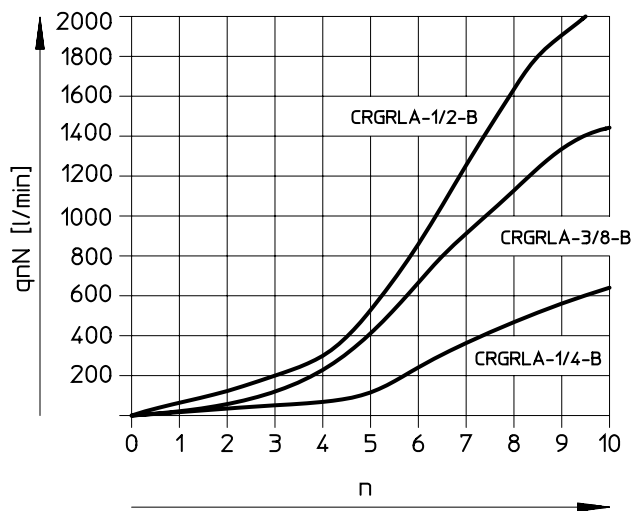

Standard flow rate q_n at 6 → 0 bar as a function of spindle rotations n

CRGRLA-1/4, CRGRLA-3/8, CRGRLA-1/2

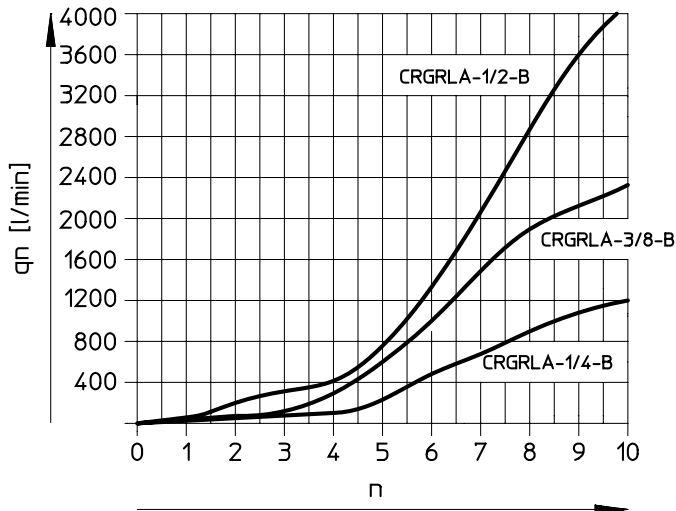

Materials

Sectional view

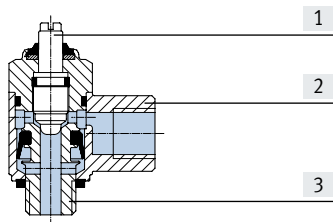

| | |
|----------------------------|----------------------------|
| One-way flow control valve | |
| [1] Adjusting screw | High-alloy stainless steel |
| [2] Swivel joint | High-alloy stainless steel |
| [3] Hollow bolt | High-alloy steel |
| - Seals | FPM, PVC |
| Note on materials | RoHS-compliant |

Datasheet – Female thread, stainless steel

Dimensions

Download CAD data → www.festo.com

CRGRLA-M5

CRGRLA-1/8, CRGRLA-1/4, CRGRLA-3/8, CRGRLA-1/2

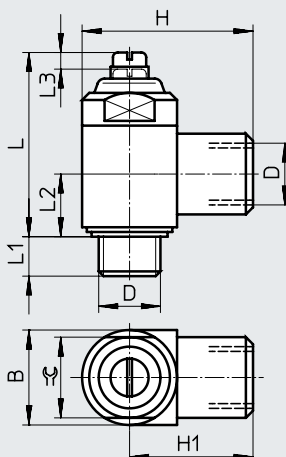
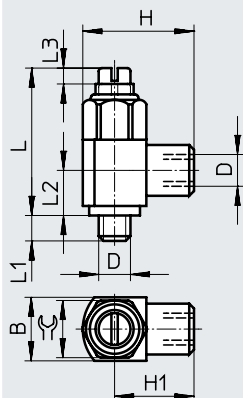

| Type | Connection D | Nominal size [mm] | B | H | H1 | ~L | ~L1 | ~L2 | ~L3 | ≙ |
|------------|--------------|-------------------|----------|--------------|------|------------|-----|------|-----|----|
| CRGRLA-M5 | M5 | 2 | 10 -0.25 | 17.5 ±0.3 | 12.5 | 22.9 ±3.5% | 4 | 7.1 | 2.5 | 9 |
| CRGRLA-1/8 | G1/8 | 4 | 16 -0.4 | 28 +0.4/-0.3 | 20 | 33.8 ±2.7% | 5.5 | 10.3 | 3.5 | 14 |
| CRGRLA-1/4 | G1/4 | 6 | 20 -0.3 | 36 +0.4/-0.2 | 26 | 38.8 ±2.7% | 6.5 | 13.2 | 3.5 | 17 |
| CRGRLA-3/8 | G3/8 | 8.5 | 25 -0.3 | 41 +0.4/-0.2 | 28.5 | 48.5 ±2.2% | 7.5 | 15.4 | 5 | 22 |
| CRGRLA-1/2 | G1/2 | 10.6 | 32 -0.4 | 53 ±0.5 | 37 | 62.2 ±1.7% | 9 | 18.9 | 7.5 | 27 |

† Note: This product conforms to ISO 1179-1 and ISO 228-1.

Ordering data

| | Pneumatic connection | | Standard nominal flow rate q _{nN} At 6 → 5 bar | | Standard flow rate q _n At 6 → 0 bar | | Weight [g] | Part no. | Type |
|--|----------------------|------|--|-------------------------|---|-------------------------|------------|----------|--------------|
| | | | In flow control direction | In non-return direction | In flow control direction | In non-return direction | | | |
| | 2 | 1 | [l/min] | [l/min] | [l/min] | [l/min] | | | |
| | M5 | M5 | 95 | 77 ... 95 | 165 | 140 ... 150 | 10.2 | 161403 | CRGRLA-M5-B |
| | G1/8 | G1/8 | 340 | 260 ... 420 | 580 | 530 ... 590 | 37.8 | 161404 | CRGRLA-1/8-B |
| | G1/4 | G1/4 | 610 | 450 ... 820 | 1265 | 1030 ... 1345 | 71.6 | 161405 | CRGRLA-1/4-B |
| | G3/8 | G3/8 | 1450 | 970 ... 1600 | 2515 | 2095 ... 2665 | 126.9 | 161406 | CRGRLA-3/8-B |
| | G1/2 | G1/2 | 2100 | 1550 ... 2200 | 4265 | 3550 ... 4325 | 262.3 | 161407 | CRGRLA-1/2-B |